

INSTALLATION MANUAL

GaLiO Insert #2

G20/G25 (Natural Gas) G30/G31 (Propane-Butane/Propane)

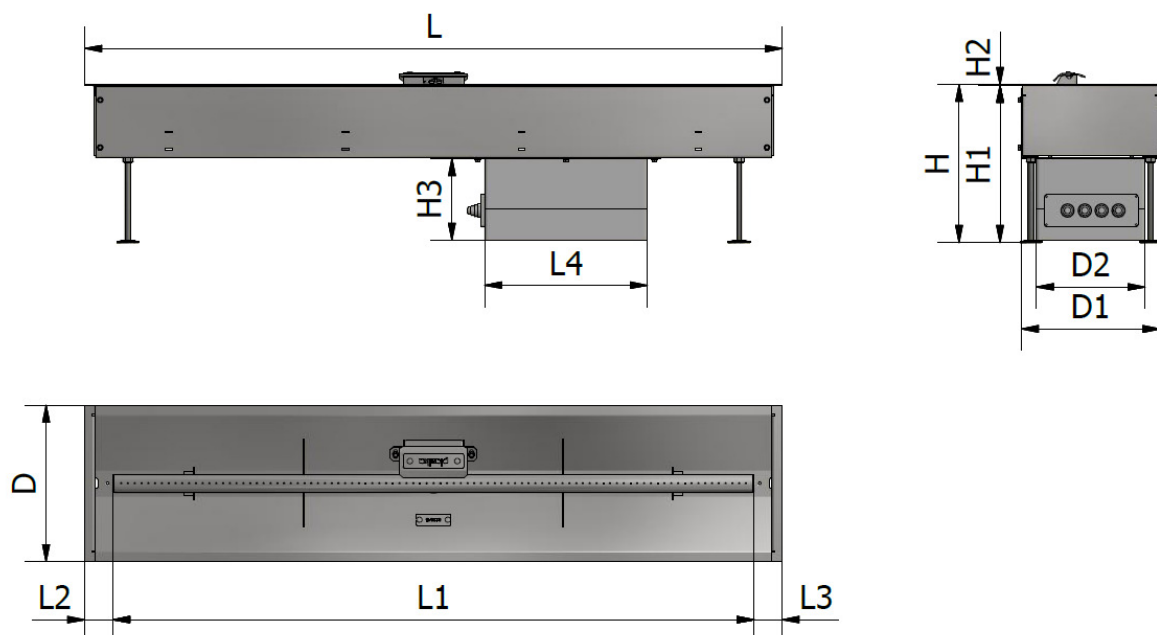
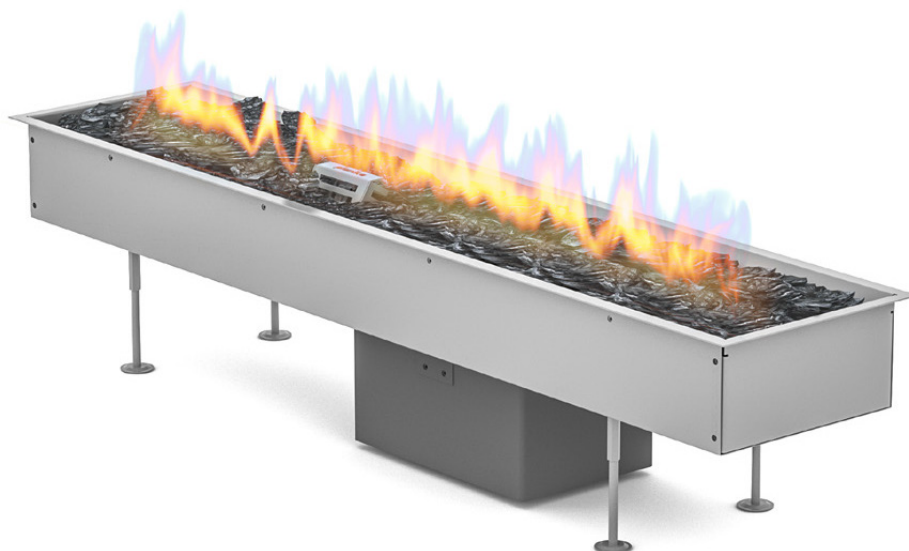

	H	H1	H2	H3	L	L1	L2	L3	L4	D	D1	D2
[mm]	260	258,5	1,5	120	1027	944	43,5	43,5	240	230	205	160

Manufactured by
Planika Sp. z o.o.
 Bydgoska 38
 86-061 Brzoza
 Poland

IT IS OBLIGATORY TO READ AND KEEP THIS INSTRUCTION MANUAL.

TABLE OF CONTENTS

1. INTRODUCTION	3
2. SAFETY INSTRUCTION	3
2.1 Safety instruction regarding the use of the gas cylinder	4
3. INSTALLATION	4
3.1. Box contents	4
4. MONTAGE	6
4.1 Directions of how to design a housing for the fireplace	8
4.1.1 The insertion variant	8
4.1.2 Montage involving use of adjustable supports	9
4.2 Control panel and gas cylinder montage	11
4.3 Possible housing variants	15
4.3.1 Situations in which montage of glass screen protection is mandatory	15
4.3.2 Situations in which the glass screen montage is forbidden	15
5. INSTALLATION OF THE GAS LINKAGE	16
5.1 Natural gas connection	16
5.2 Connection and replacement of the gas cylinder (LPG version)	16
5.3 Adapters for the gas cylinder connection (LPG version)	18
5.4 Pressure regulator replacement (LPG version)	19
6. TECHNICAL SPECIFICATION	20
7. MANUFACTURER'S CONTACT DETAILS	21

1. INTRODUCTION

The GaLiO Insert fireplace is a decorative fuel-effect gas appliances intended only for outdoor use. It is obligatory to acquaint oneself with the below installation manual and user's manual before committing to the installation and use of the GaLiO Insert fireplace. This manual is to be kept safe for the lifetime of the device.

2. SAFETY INSTRUCTION

- Read the instruction before using the device.
- Use only outdoors.
- The GaLiO Insert is not a free-standing device and is destined to be housed.
- The montage of the device must take into account its trouble-free removal in case of service.
- Do not start up the device before it's placed safely into the prepared housing.
- The GaLiO Insert fireplace should be installed and controlled annually according to the below installation manual as well as enforced national and local laws regarding gas safety (installation and use).
- One needs to assess whether the data on the product plaque complies with the local type of gas and pressure.
- Do not change the structure of the device or its sealed elements nor modify the default settings of the GaLiO Insert fireplace.
- Do not set any additional imitation blocks nor any glowing coal fragments on the burner or in the combustion chamber.
- A ventilation grid or slot with a ventilation area of 150cm² is required at the base of the housing. A device without the grid or slot for ventilation will function incorrectly causing a threat of damaging the unit or causing a fire.
- A CO₂ or a powder fire extinguisher needs to be placed near the device.
- During the first ignition the GaLiO Insert fireplace needs to be burnt on maximum level for a few hours in order for the elements to acquire correct temperature and for the remains of paint, lacquer and lubricant to evaporate.
- Do not move the device while it's working.
- The GaLiO Insert fireplace was designed for decorative purposes. The surface of the GaLiO Insert fireplace (including the optional glass screens) may get hot (up to 100 degrees Celsius). **WARNING!**: parts of the device that are easy to reach may be very hot. Keep children away from the device.
- Some variants of housing for the device may require installing additional toughened glass screens (provided separately).
- Install the fireplace away from flammable materials.
- When the GaLiO Insert fireplace is on it's not to be exposed to rain.
- When not being used the GaLiO Insert is to be protected from atmospheric conditions and the main valve of the gas cylinder needs to be turned off.
- All parts of the GaLiO Insert fireplace are made of stain resistant material.
- Never leave a turned on GaLiO Insert without supervision.
- The GaLiO Insert fireplace needs to be installed in a place inaccessible for children, unauthorised persons or animals for the direct contact with the flame or hot parts of the device to be impossible.
- In case of heavy wind the GaLiO Insert fireplace needs to be immediately turned off and one needs to wait until the heavy wind passes.
- In case of noticing any sort of gas leaks the fireplace as well as the main valve of the gas cylinder need to be turned off.
- After use turn off the gas cylinder valve.

2.1 Safety instruction regarding the use of the gas cylinder

- Use only the type of gas and pressure specified by the manufacturer.
- The gas cylinders should always be placed in a vertical position – during use and transport.
- Always store the gas cylinder in an easily accessible place to allow its immediate turn-off.
- During the installation process do not allow an open flame or any ignited object to reach the gas cylinder.
- The gas cylinder should be in a distance not shorter than 1,5 metres away from the GaLiO Insert fireplace.
- Leaks should be found with the use of a cleaning liquid and water. If bubbles form on the surface that means that there's an existing leak.
- Always use a pressure regulator between the gas cylinder and the device. Replace the pressure regulator every 5 years. The allowed pressures are: 30mbar, 37mbar (recommended), 50 mbar. Use only regulators complying with the European EN16129 Norm.
- Use only approved and certified gas connection linkage. Replace the linkage every 2 years.
- The elastic linkage connecting gas to the fireplace is to be led away from sharp edges and hot surfaces. Refrain from bends and twists of the elastic connection on its full length.
- Remember that the LPG bottle should be stored in a well-ventilated place. LPG gas is heavier than air and its accumulation near the surface may generate an explosive mixture.
- The housing in which the LPG bottle is (optionally) placed needs to have an appropriate ventilation. The housing needs to have an upper ventilation slot above the top of the bottle (of an area min 1/100 of the area of the base of the housing) and a lower ventilation slot (of an area min 1/50 of the area of the base of the housing).
- The gas cylinder needs to be shut if the fireplace is not being used.
- Filling the gas cylinders is to be commissioned to certified gas filling stations.
- Replacement of empty bottles for full ones is to be conducted only in authorized locations.

3. INSTALLATION

3.1. Box contents

- 1x complete gas fireplace
- 1x Wall Switch
- 4x AA Batteries
- 4x bag of decorative stones
- 1x 4 metre rubber gas linkage – installed (only LPG version)
- 1x pressure regulator (37mbar) – installed (only LPG version)
- 1x Euro Set (only LPG version)
- 1x installation manual
- 1x user's manual

3.2. Unboxing and installation

- The contents of the boxes need to be carefully unwrapped from the foam foil.
- Remove the bags with decorative stones from the burner reservoir and place them away from it.
- Remove the Styrofoam placed on the unit.
- Check the completeness of the elements with the contents list.
- Make sure that the insert nor its elements weren't damaged during the transportation (if they were, notify the supplier).
- Install the GaLiO Insert fireplace in the prepared housing made according to the montage specification.
- The decorative stones are to be scattered evenly around the reservoir to completely cover the burner of the fireplace.
- **WARNING!!!** The stones may not cover or be placed inside the device protecting the ignition unit. (Photo 1)



Photo 1

- In the case of GaLiO Insert powered with natural gas, to obtain the optimum image of the flame, cover the burner with a single layer of decorative stones leaving some spaces uncovered of approximately every 10 cm (Photo 2).

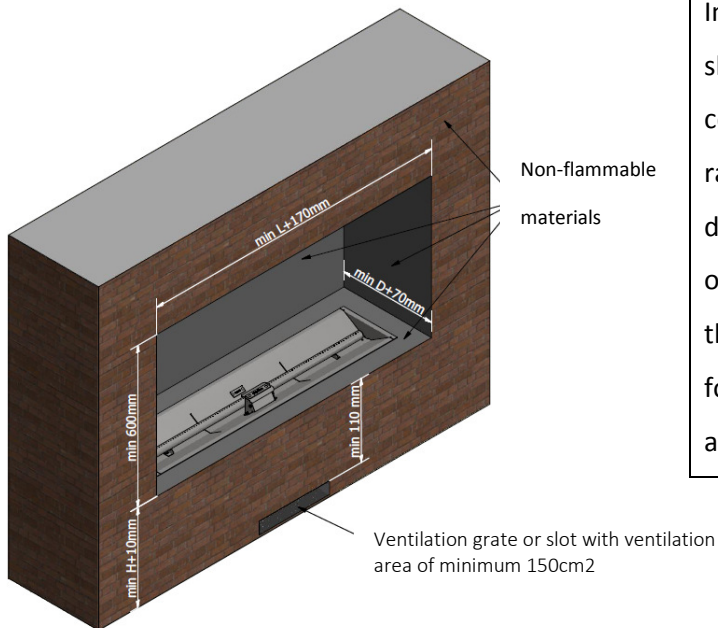

Photo 2

- If all the points were completed according to the instruction the gas cylinder can be now connected.

4. MONTAGE

WARNING!!! All elements above the fireplace need to be made of non-flammable materials.



In accordance with fire safety measures there should be no flammable objects in direct contact with the device nor within a 1 metre radius from the fire. Additionally, Planika doesn't recommend placing heat-sensitive objects above the fireplace as it may shorten their lifetime. Planika will not be responsible for any damage caused by high temperature affecting objects installed above the fire.

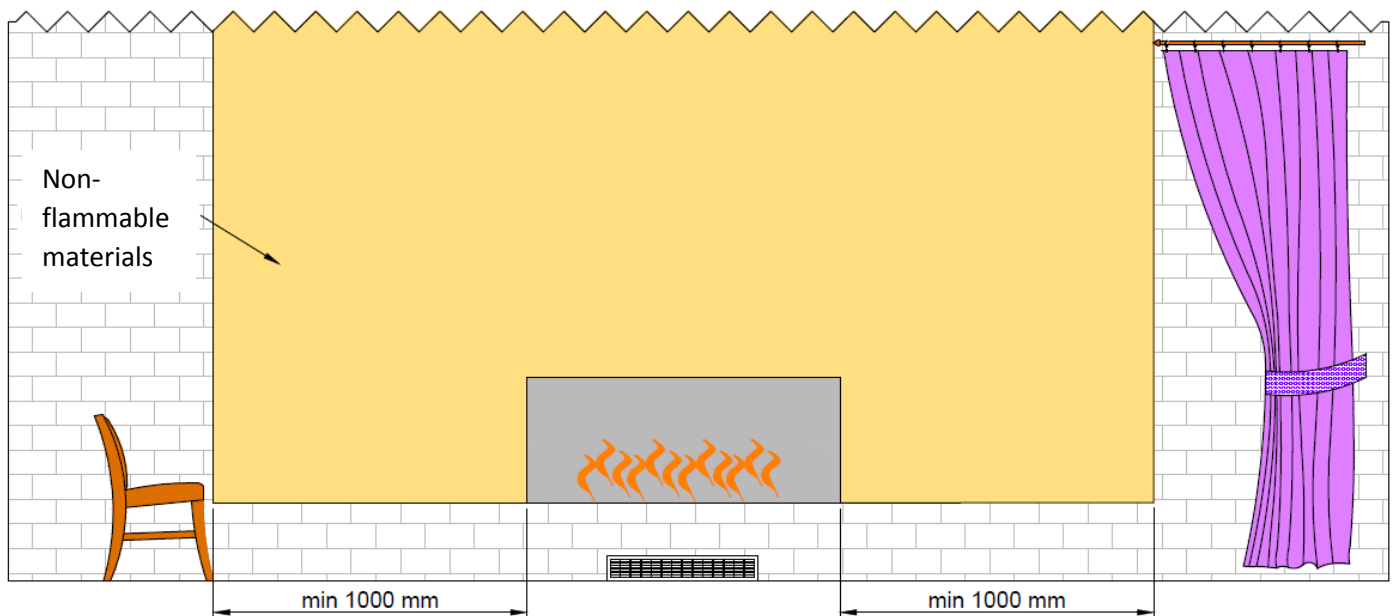

- The dimensions of the housing are to be chosen according to the technical drawings and a ventilation grid or slot – with ventilation area min 150cm² – needs to be placed near the base of the unit, minimally 110 mm below the burner surface.

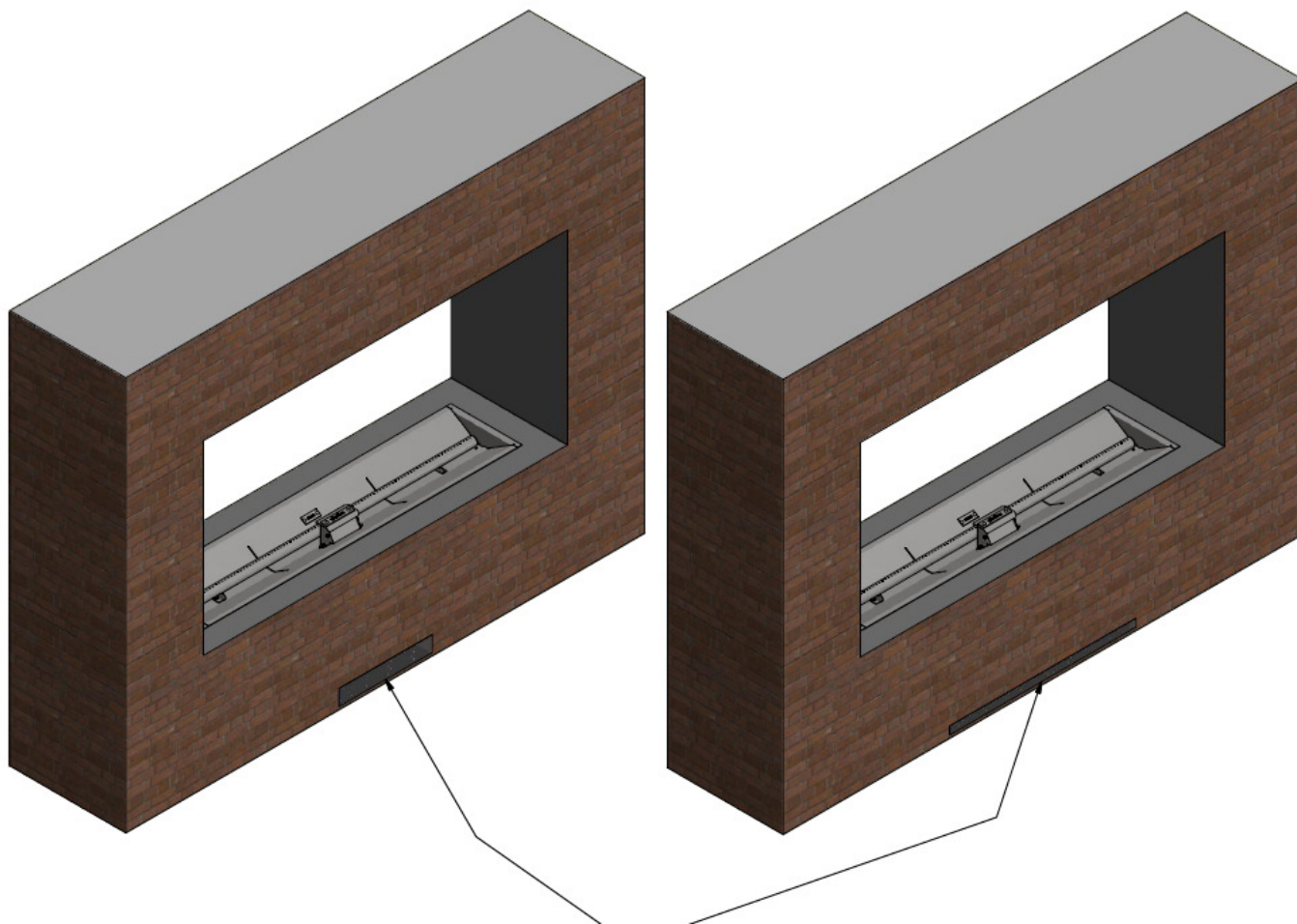

The dimensions and shape of the ventilation grid may be designed according to client specifications however both the minimum ventilation area of 150 cm² as well as minimum distance from the edge of the housing of 110 minimum need to be observed.

- If a hood is placed above the burner it needs to be made of non-flammable materials and a minimum distance of 60 cm from the surface of the burner needs to be observed. **WARNING!!! If the housing is devoid of a diagonal hood above the burner one needs to remember that all surfaces inside the housing exposed to contact with hot air need to be made of non-flammable materials.**
- It is not permitted to use a device which is not housed in some way.

4.1 Directions of how to design a housing for the fireplace

4.1.1 The insertion variant

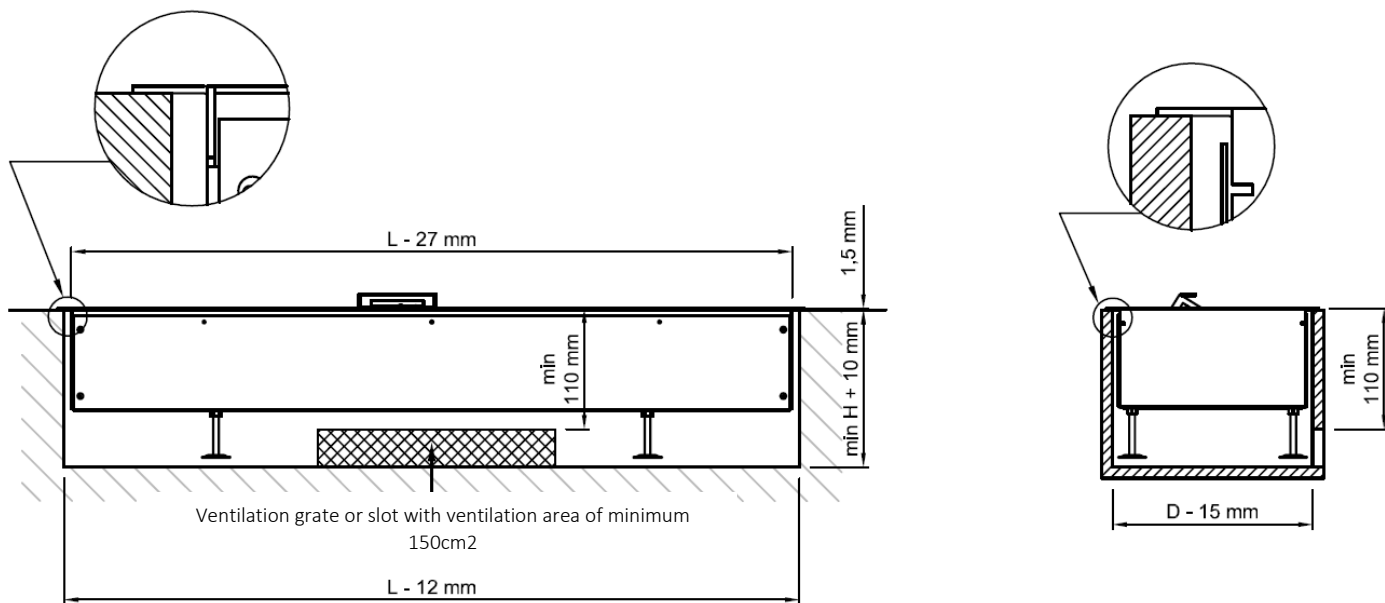

- Make the cavity for the insert according to the below outline. When preparing the cavity make sure the surface on which the insert is placed is well-levelled as there is no option of levelling out the insert.

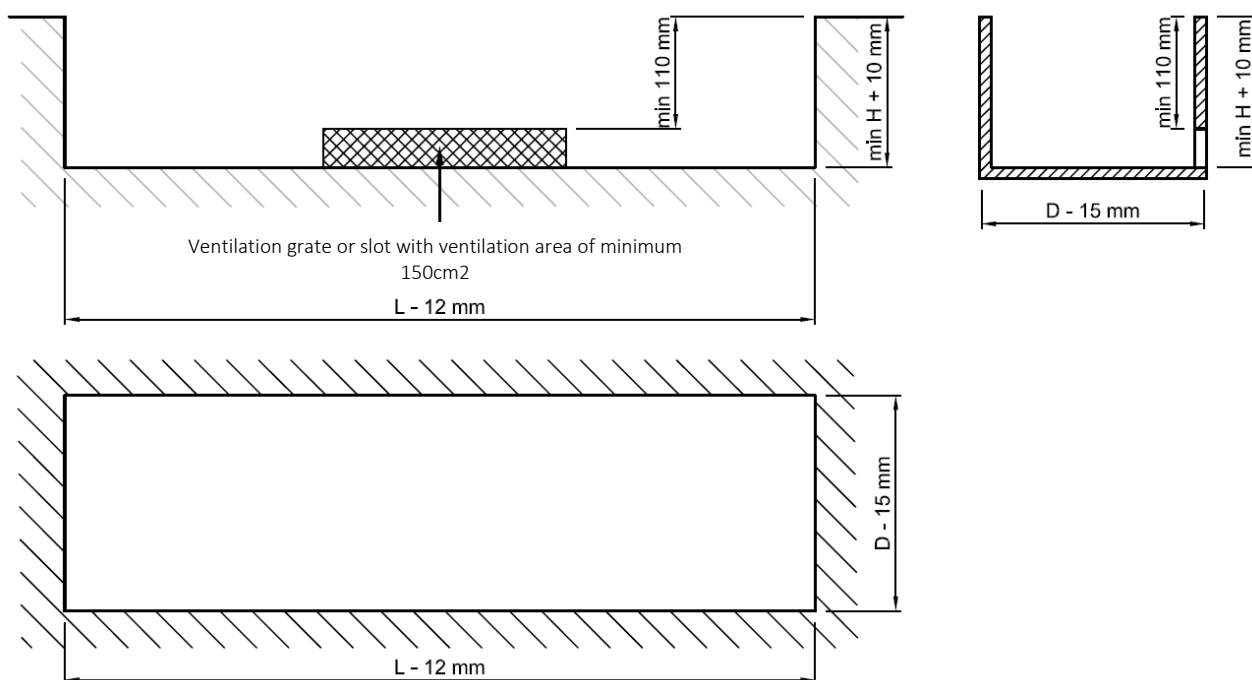

- The level difference between the edges of the fireplace cannot exceed 2 mm. Incorrect levelling may cause incorrect operation of the device and in a worst case scenario, a fire.

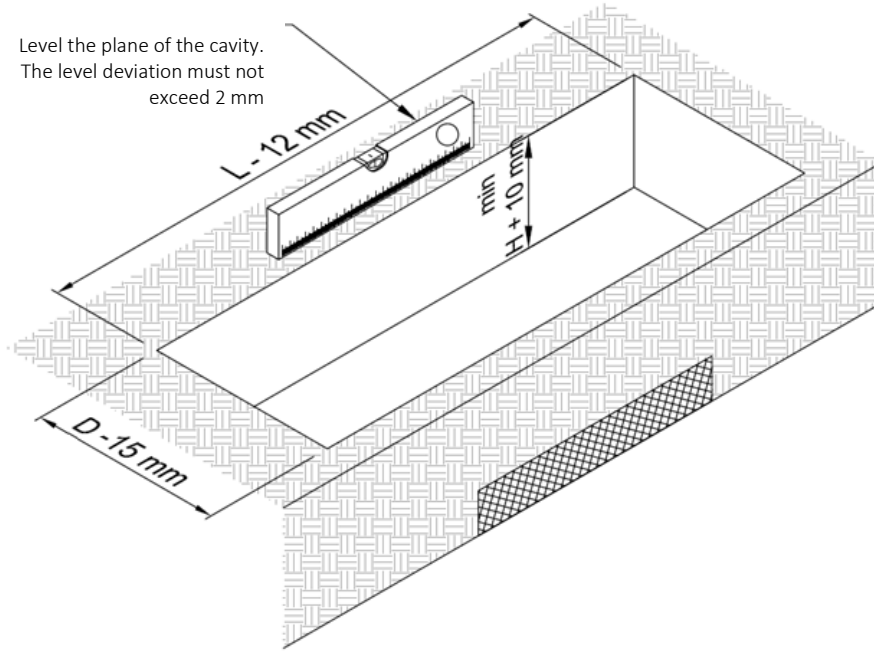

4.1.2 Montage involving use of adjustable supports

- In this montage variant the insert is using the help of supports attached to the device. An appropriate space needs to be provided around the fireplace allowing its trouble-free installation and providing correct circulation inside the fireplace.

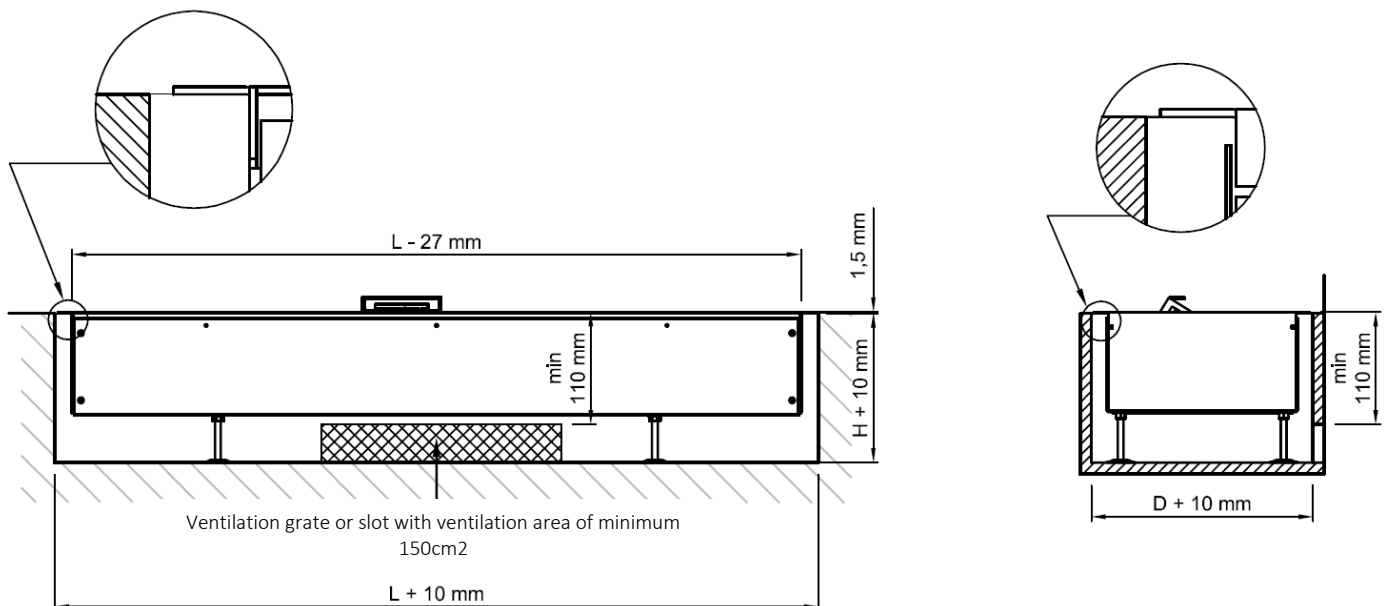

- Prepare the cavity for the insert according to the below scheme. When preparing the cavity take into account that the surface on which the insert is going to be placed needs to be well-levelled as the adjustable supports have a limited range of levelling of the insert. The delivered device is already levelled.

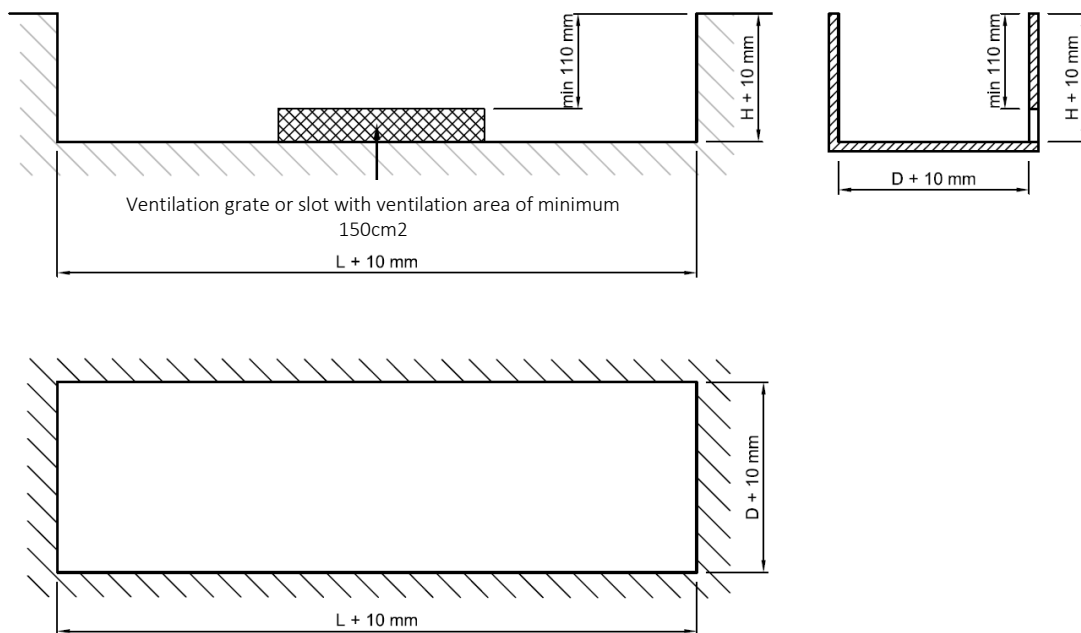

- The edges of the cavity in which the insert is to be placed need to be finished in an aesthetic way as they will be visible during normal use of the device.
- In case of the cavity being deeper than the height of the device on supports Planika permits a solution where the device is set on a stable and levelled plinth placed on the bottom of the cavity. The top surface of the plinth should be **H + 10 mm** away from the top of the surface of the housing. The ventilation slot or grid must be placed at the bottom of the housing.



- The level difference between the edges of the fireplace cannot exceed 2 mm. Incorrect levelling may cause incorrect operation of the device and in a worst case scenario, a fire.

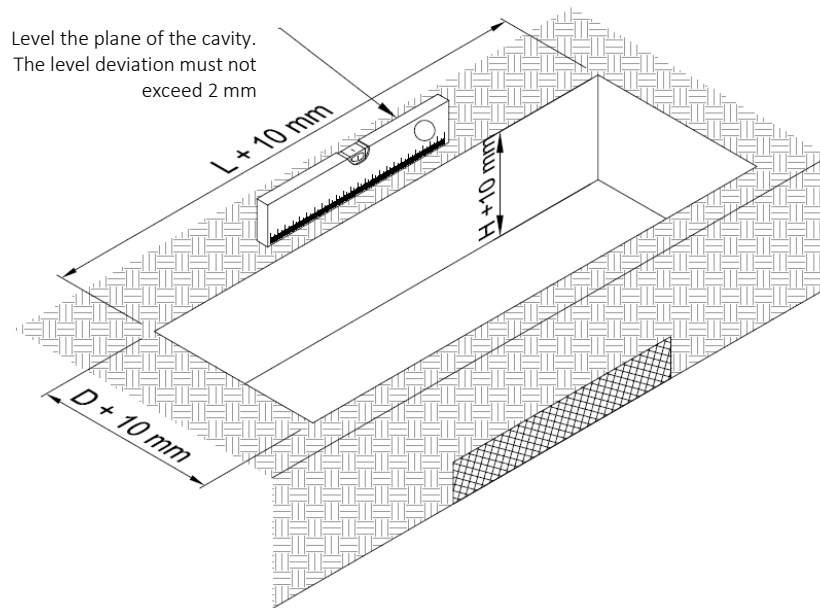

4.2 Control panel and gas cylinder montage

4.2.1 Montage of the gas cylinder.

- The control panel along with the gas valve is inseparably connected with the GaLiO Insert fireplace through elastic gas linkage and the ignition linkage.

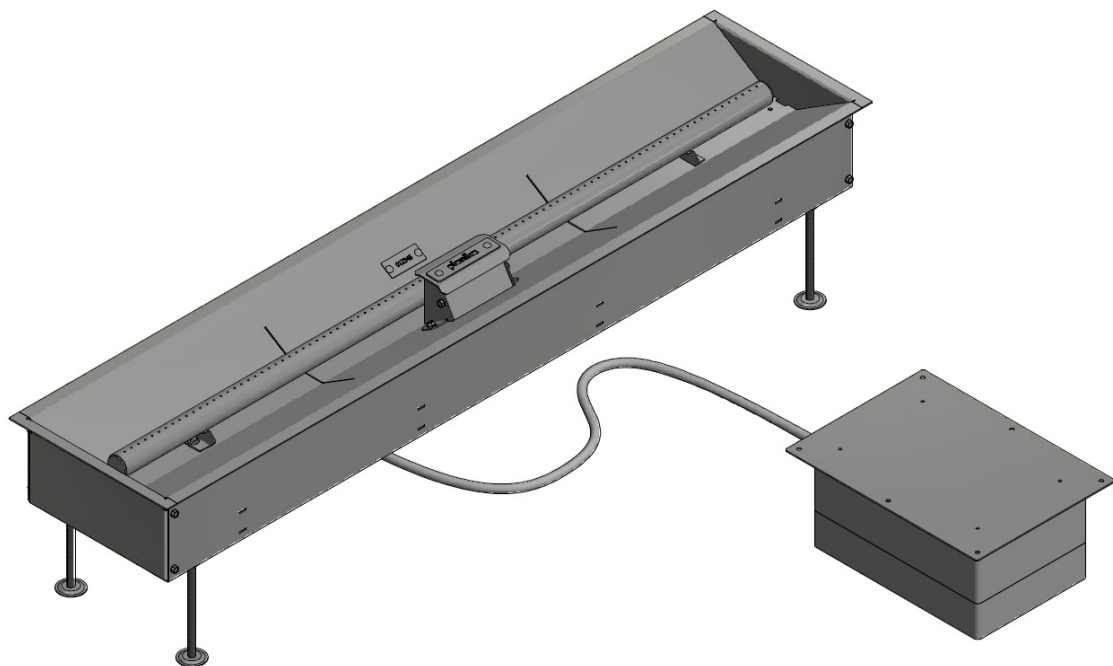

- **WARNING!** In case of installation of the control panel underneath the device it is crucial to manufacture a slot in the side of the housing where the insert is placed for the gas linkage and the pressure regulator (**only in case of LPG version**).

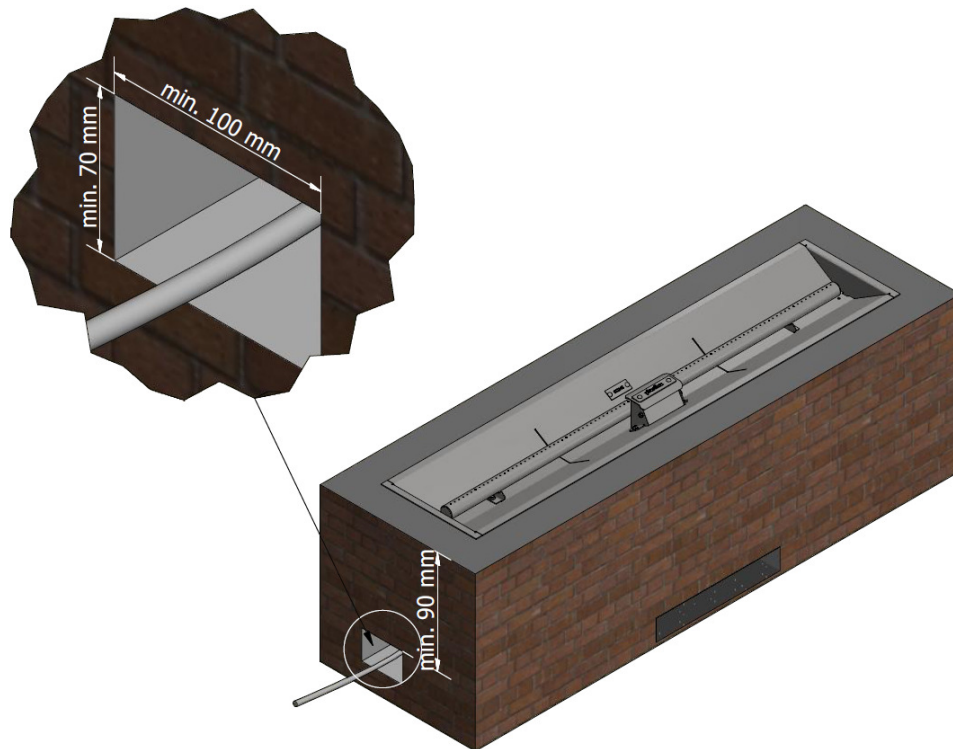

- The gas linkage attached to the device allows to place the gas cylinder maximally 3 metres away from the connected control panel, however it cannot be placed nearer to the device than 1,5 metres.

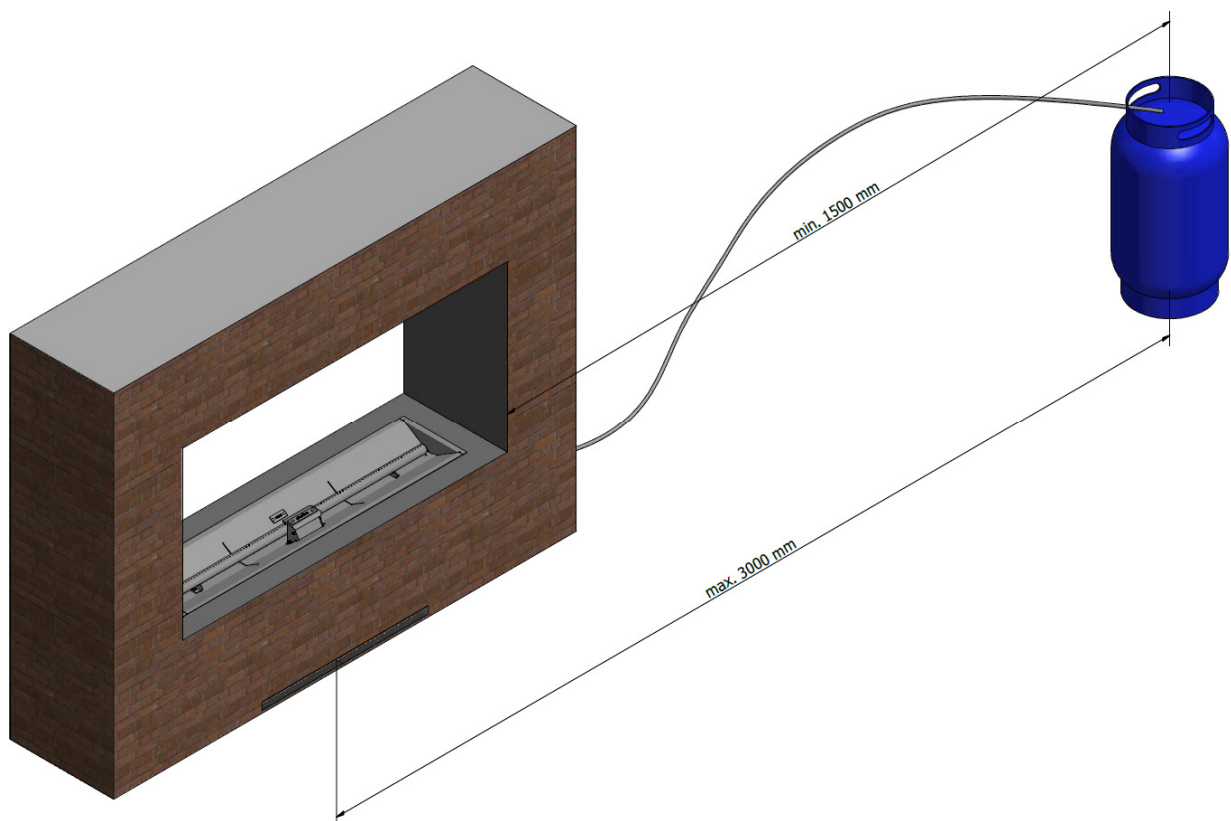

- The optional housing for the gas cylinder cannot be airtight and has to be correctly ventilated. The housing needs to have an upper ventilation slot above the top of the bottle (of an area min 1/100 of the area of the base of the housing) and a lower ventilation slot (of an area min 1/50 of the area of the base of the housing). The dimensions of the housing may vary to accommodate different types and dimensions of the gas cylinders however they also have to be sufficient for hassle-free installation of the gas cylinder.

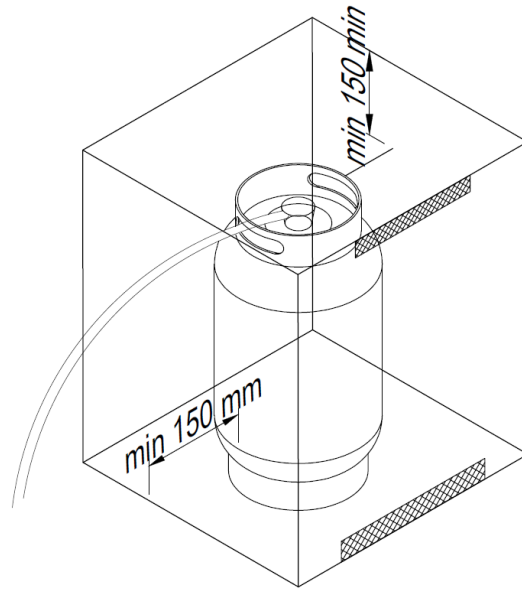

4.2.2 Control panel montage in a separate storage

The control panel along with the gas valve connected with the insert through elastic linkage may be installed away from the housing for the GaLiO Insert. It can be placed maximally within a 1 metre radius from the centre of the device.

- Before placing the insert into the housing the control panel needs to be placed in an easy-to-reach spot allowing convenient control of the device and, if necessary, quick shutdown and cut-off of gas supply. The control panel may be installed in a horizontal or vertical position with the use of angles attached to it.

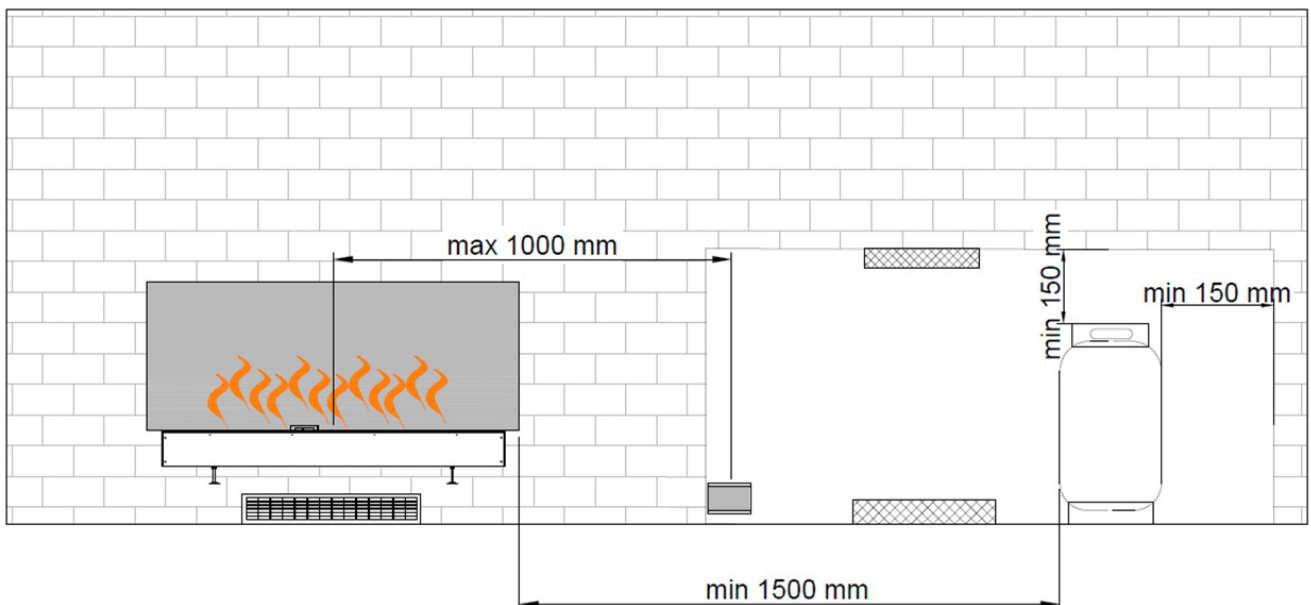

- The control panel may be installed in the same housing where the gas cylinder is installed, however one has to remember that the housing cannot be airtight and the gas cylinder needs to be placed minimally 1,5 metres away from the source of fire. The housing needs to have an upper ventilation slot above the top of the bottle (of an area min 1/100 of the area of the base of the housing) and a lower ventilation slot (of an area min 1/50 of the area of the base of the housing). The dimensions of the housing may vary to accommodate different types and dimensions of the gas cylinders however they also have to be sufficient for hassle-free installation of the gas cylinder. Control panel montage above the gas cylinder is not recommended as it would impede its hassle-free installation and replacement.

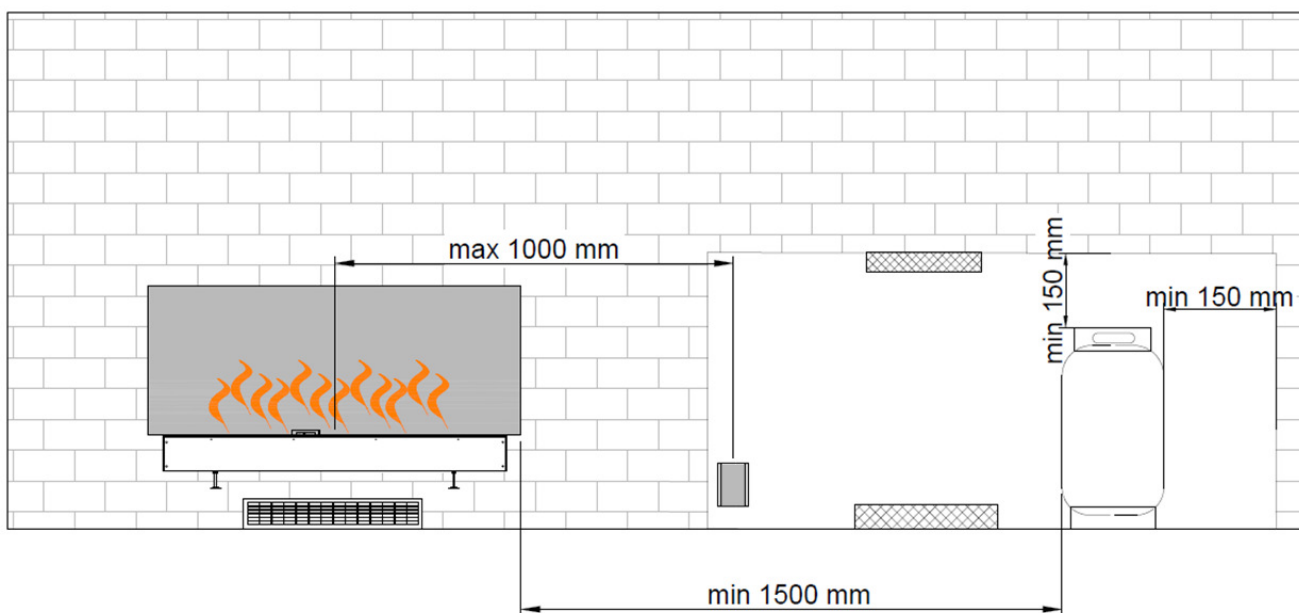

WARNING!!!

- After making sure that the device has been correctly installed acquaint yourself with the attached User's Manual.
- Only after acquainting yourself with the User's Manual and correctly attaching the gas linkage may you start the device.
- If in future a need arises of having to take the insert out of the housing it may only be done when the device is turned off and cooled down and the valve on the gas cylinder is closed.
- Keep this instruction manual for the lifetime of the device.

4.3 Possible housing variants

In all below housing variants please use the above mentioned rules regarding correct montage.

4.3.1 Situations in which montage of glass screen protection is mandatory

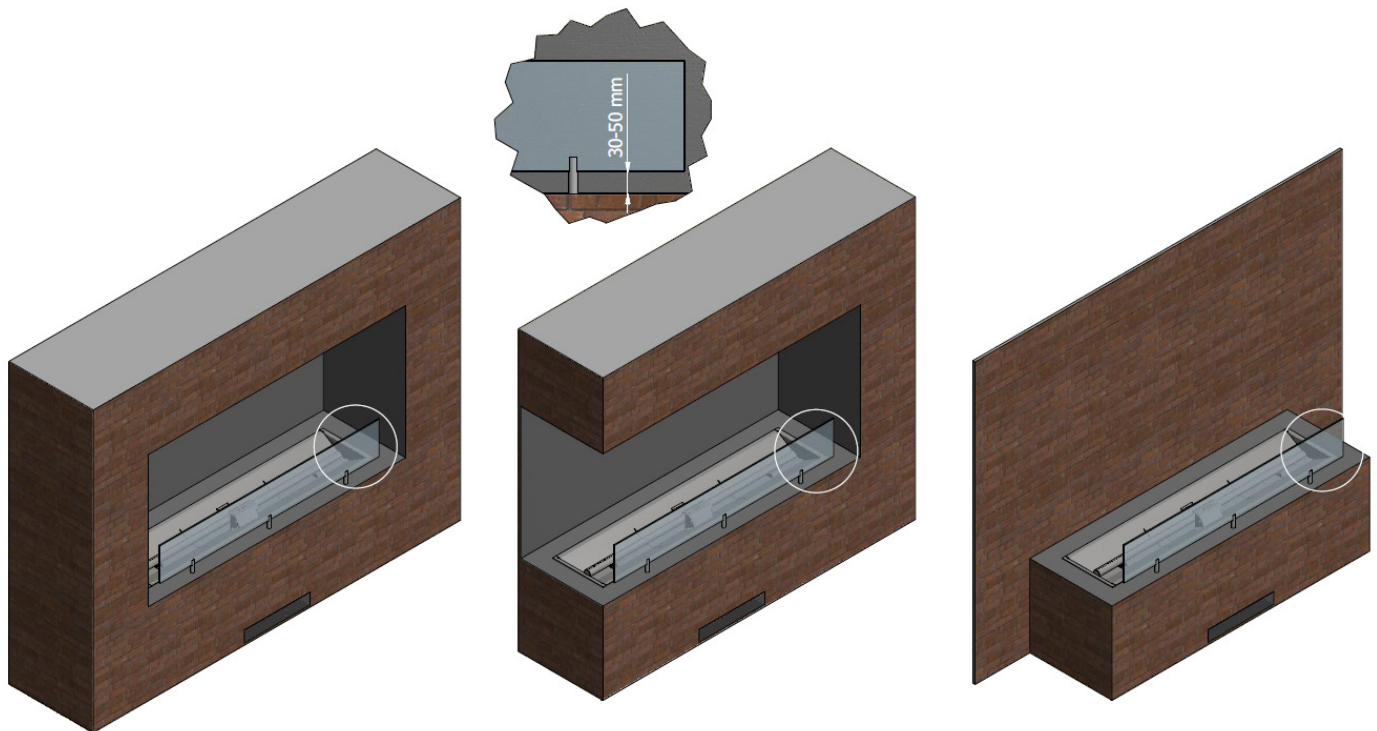

4.3.2 Situations in which the glass screen montage is forbidden.

The montage of toughened glass screen panels is advised (and recommended) on both sides of the fireplace in this case or leaving those sides without the montage of the glass screen. In this case one has to put an emphasis on safety measures and disallow children, unauthorised persons and animals to have a direct contact with the fire.

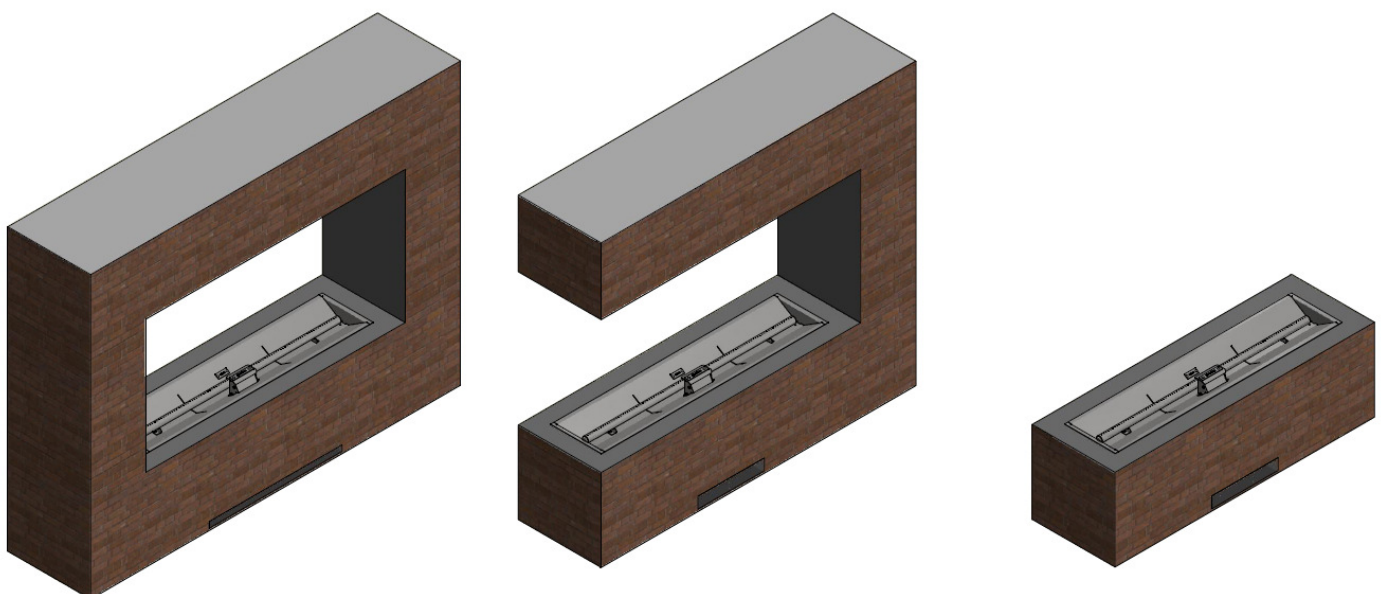

5. INSTALLATION OF THE GAS LINKAGE

Warning!!! The montage and service needs to be conducted by a qualified professional, a company or the gas supplier.

Before proceeding with the connection of the gas cylinder to the fireplace all activity regarding the correct placement and installation of the GaLiO Insert needs to be already performed. Place the gas linkage away from hot or sharp edges and make sure it is not twisted.

5.1 Natural gas connection

First and foremost, make sure that the connecting device is designed to supply a gas suitable for the type placed in the gas installation. All necessary information regarding the desired parameters of the gas are found on the rating plate of the device. Before connecting the gas supply, it is necessary to blow them to remove any remaining metal filings and other contaminants from inside. Automatic gas control system should be protected from moisture and dust. These factors may cause irreparable damage to the individual components. The pipe supplying gas to the fireplace should be equipped with a ball valve with a recommended diameter of 1/2 inch. The individual elements of the gas installation cannot be sealed using Teflon tape or PTFE tape.

The gas valve on the gas pipe must be installed in accordance with applicable national regulations. Before connecting the gas, make sure that the gas pipes and connections have no dirt. Gas connection is finished with external thread 3/8 ". Regarding gas connection, the following requirements shall apply:

- You must use the gas pipe with the correct dimensions, so there is no pressure loss.
- Ball gas valve should be installed in an easily accessible place and have the necessary CE mark.

5.2 Connection and replacement of the gas cylinder (LPG version)

The GaLiO Insert is delivered together with an elastic gas linkage which, on one end is connected to the valve of the device and on the other end to the 37mbar regulator (in the twist-on version) ready to be connected to the gas cylinder. One needs to control the expiry date of both of the regulator as well as the gas linkage and if necessary (for instance: broken, cut, scratched linkage) replace the components for new ones according to national standards and norms.

The GaLiO Insert fireplace can use metal or steel bottles or composite bottles filled with propane-butane gas or propane gas. This device features a twist-on regulator with current pressure of 37mbar. It can be replaced into a regulator with a quick-release with pressure regulator of 37 mbar.

WARNING!!! NEVER use an unstable gas connection or a regulator for other gas pressure.

Gas cylinders have two types of connectors:

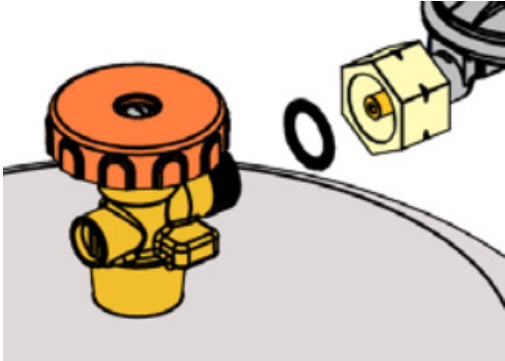
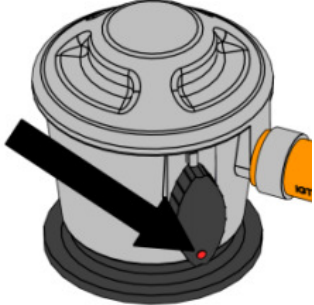
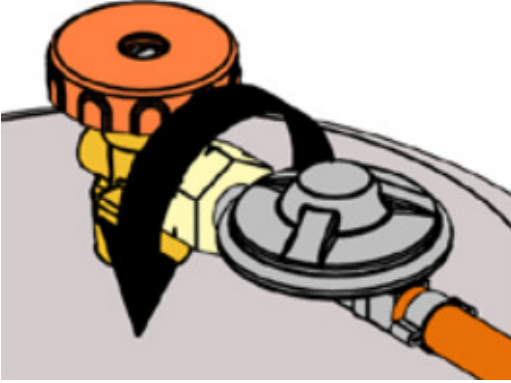
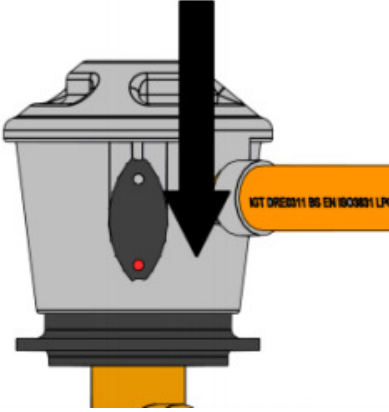
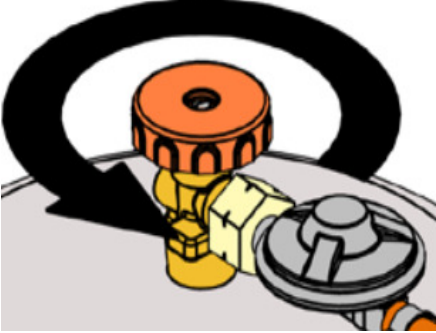
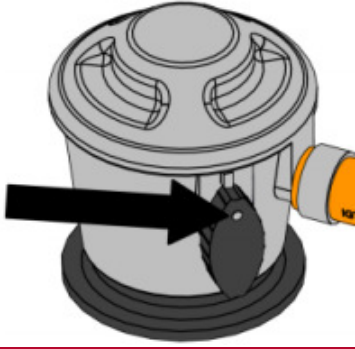

- Twist-on connection: The most important thing is the black seal. Always check if the seal is present and that it hasn't been damaged during the gas cylinder replacement. Some connections have a knob to fasten them in place while others require the use of a wrench. Tighten securely (left thread). Using the tool pay attention not to fasten the connection too tightly as this may damage the seal.
- Quick-release: For this type of connection no tool is required. On/off regulation of gas connection is made through a switch on the regulator or on a special connector. In case of using a connector with a thread regulator of an old type put a special emphasis on checking if the connecting nut has been tightly fastened with the help of wrench.

Gas cylinder connection

Twist-on connection	Quick-release
<ol style="list-style-type: none"> 1. Check if the bottle valve is TURNED OFF turning it clockwise 2. Remove the protection tip and store it for later use. 	<ol style="list-style-type: none"> 1. Remove the protection tip. Do not use any tools, leave the tip hanging freely.
<ol style="list-style-type: none"> 3. Before making the connection check if the black seal is not damaged. 	<ol style="list-style-type: none"> 2. Make sure all the taps on the gas device are closed and if the switch is in the OFF position. 
<ol style="list-style-type: none"> 4. Fit the connecting nut to the cylinder with the use of a correct wrench or the connecting knob. (left thread) Do not allow the gas cylinder connectors to be fastened too tightly. 	<ol style="list-style-type: none"> 3. Place the quick-release regulator on the valve and press it down hard. If the switch is correctly turned off you will hear a characteristic click. 
<ol style="list-style-type: none"> 5. When the gas flow is required turn the valve of the bottle counter-clockwise. 	<ol style="list-style-type: none"> 4. To let the gas flow in turn the switch into the ON position (or into the flame image). 

- Place the gas cylinder in a correct distance from the fireplace (min 1,5 metres away).
- **WARNING!!!** Check the gas connection for leakage. If anything suggests a leak is present (for instance a characteristic gas smell) close the gas cylinder valve and under no circumstances turn the device on before removing the leak.
- After removing the leak one may open the gas cylinder valve again.

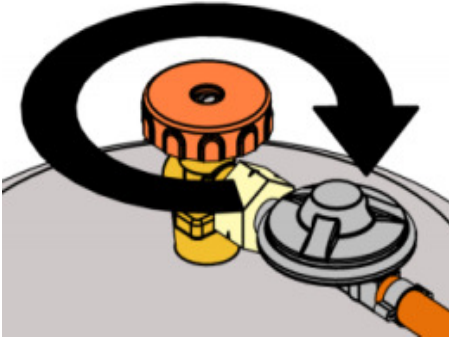
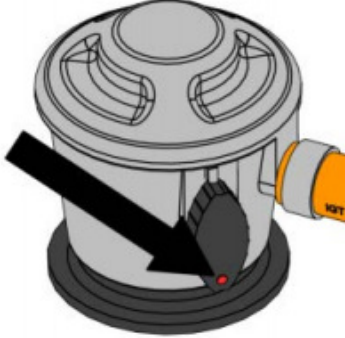
Disconnection of the gas cylinder

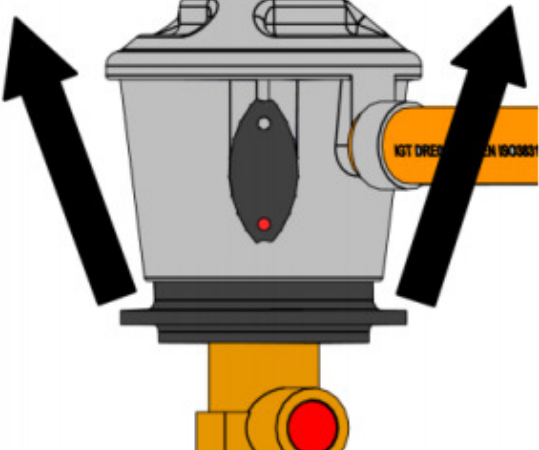
Twist-on connection	Quick-release
<p>1. Turn off the GaLiO Insert – put it into the OFF position. The main and pilot burner need to be turned off.</p>	<p>1. Turn off the GaLiO Insert – put it into the OFF position. The main and pilot burner need to be turned off.</p>
<p>2. Turn the bottle valve into the OFF position (clockwise).</p> 	<p>2. Turn the switch into the OFF position.</p> 
<p>3. NEVER DO NOT unmount the regulator (or connecting nut) when the bottle valve is open.</p> <p>4. TAKE OFF the regulator (or the connecting nut) with the use of a wrench or a connecting knob.</p> 	<p>3. Take off the quick-release regulator by pressing the switch horizontally and simultaneously pulling the whole regulator upwards.</p> 
<p>5. REPLACE the linkage closer or cap on the empty or partially full bottle if it's not being used.</p>	<p>4. REPLACE the tightening cap on an empty or partially full bottle if it's not being used.</p>

5.3 Adapters for the gas cylinder connection (LPG version)

When the thread of the installed pressure regulator does not fit into the thread on the valve of the gas cylinder, it is necessary to use an appropriate adapter that is delivered with the device.

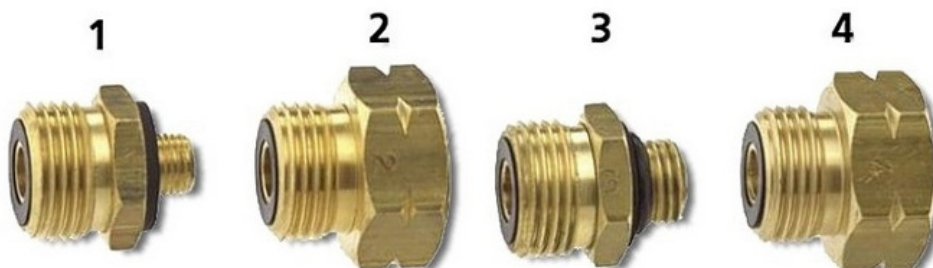



1 - Italy, Switzerland: external thread M 10 x 1;

2 - Italy, Greece, Austria, Slovenia: internal thread W20X1/14 LH;

3 - United Kingdom, Finland, Iceland, Norway, Portugal, Sweden: external thread M14x1,5;

4 - Belgium, United Kingdom, France, Netherlands, Ireland, Croatia, Lithuania, Luxembourg, Macedonia, Montenegro, Serbia, Slovakia, Slovenia, Switzerland, Spain, Czech Republic: internal thread W21,8x1/14 LH.

5.4 Pressure regulator replacement (LPG version)

<p>1. You always need to use a pressure regulator between the gas cylinder and the device. Replace the pressure regulator every 5 years. Allowed pressures: 30 mbar, 37 mbar (recommended), 50 mbar. Use only the redactors that comply with the EN16129 European Norm.</p> <p>2. Turn off the GaLiO Insert – the „OFF” position. The main burner and the pilot burner need to be turned off.</p> <p>3. Disconnect the regulator from the gas cylinder (description above).</p>	
<p>4. Loosen the metal clamp with the use of a screwdriver (philips) or a flat wrench.</p>	
<p>5. Move the clamp away from the stub of gas regulator.</p>	
<p>6. Take off the linkage from the stub of regulator.</p>	

7. Attach a new linkage on the stub of regulator.	
8. Move the clamp into the stub again and tighten it. WARNING! In the event of visible damage on the clamp, replace it for a new one.	

6. TECHNICAL SPECIFICATION

Gas category		I3B/P(30); I3P(30); I3+(28-30/37)	I3B/P(37); I3P(37);	I3B/P(50); I3P(50);	I2E(20); I2H(20);
Device type		A1 Outdoor	A1 Outdoor	A1 Outdoor	A1 Outdoor
Reference gas		G30/G31	G30/G31	G30/G31	G20
Net input (Hi)	kW	10,3	11,8	12,9	9,4
Input pressure	mbar	30	37	50	20
Gas flow at 15°C and 1013 mbar	m ³ /h	-----	-----	-----	1,0
Gas flow at 15°C and 1013 mbar	kg/h	0,81	0,93	1,02	-----
Burner pressure at max flame height	mbar	22,2	27,3	35,4	11,0
Nozzle of the main burner	mm	2,2	2,2	2,2	2,7
Pilot unit		G30-ZP2M-L	G30-ZP2M-L	G30-ZP2M-L	G30-ZP2M-L
Gas control valve		Mertik GV 60	Mertik GV 60	Mertik GV 60	Mertik GV 60
Gas linkage		Ø9mm	Ø9mm	Ø9mm	External 3/8"

7. MANUFACTURER'S CONTACT DETAILS

Manufacturer: Planika Sp. z o.o.
Address: Bydgoska 38
86-061 Brzoza
Poland
Telephone: + 48 52 364 11 60
Fax: + 48 52 364 11 70